

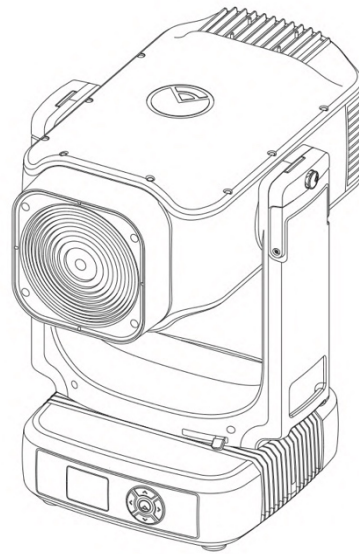

**AYRTON**  
Digital Lighting



**RIVALE WASH**

**User Manual**

## CONTENTS





1. SAFETY INSTRUCTIONS	1
2. FEATURES	2
3. FIXTURE OVERVIEW	3
4. DRAWINGS	3
5. INSTALLATION INSTRUCTIONS	4
6. DMX-512 CONTROL CONNECTION	5
7. DMX-512 CONNECTION WITH DMX TERMINATOR	6
8. DEVICE DMX START ADDRESS SELECTION	6
9. OPERATING INSTRUCTIONS OF THE INTERNAL DMX WIRELESS SYSTEM	6
10. DISPLAY	6
11. DMX PROTOCOL	7
12. ERROR MESSAGES	7
13. CLEANING AND MAINTENANCE	7

# 1. SAFETY INSTRUCTIONS

## 1.1. IMPORTANT SAFETY WARNINGS

This device has left the factory in perfect condition. In order to maintain this condition and to ensure safe operation, it is absolutely necessary for the user to follow the safety instructions and warning notes written in this user manual.

In order to install, operate and maintain the lighting fixture safely and correctly we suggest that the installation and operation be carried out by qualified technicians and these instructions be carefully followed.

	<p style="text-align: center;"><b>CAUTION!</b></p> <p>HIGH VOLTAGE. RISK OF SEVERE OR FATAL ELECTRIC SHOCK.</p>
	<p style="text-align: center;"><b>CAUTION!</b></p> <p>ALWAYS DISCONNECT MAINS SUPPLY BEFORE REMOVING ANY FIXTURE COVERS.</p>
	<p style="text-align: center;"><b>CAUTION!</b></p> <p>NEVER LOOK DIRECTLY INTO THE LIGHT SOURCE. SENSITIVE PERSONS MAY SUFFER AN EPILEPTIC SHOCK.</p>
	<p style="text-align: center;"><b>CAUTION!</b></p> <p>NEVER TOUCH THE DEVICE DURING OPERATION. COVERS MAY BE HOT</p>
	<p style="text-align: center;"><b>CAUTION!</b></p> <p><b>WARNING:</b> CHANGES OR MODIFICATIONS TO THIS UNIT NOT EXPRESSLY APPROVED BY THE PARTY RESPONSIBLE FOR COMPLIANCE COULD VOID THE USER'S AUTHORITY TO OPERATE THE EQUIPMENT.</p> <p><b>NOTE:</b> THIS EQUIPMENT HAS BEEN TESTED AND FOUND TO COMPLY WITH THE LIMITS FOR A CLASS A DIGITAL DEVICE, PURSUANT TO PART 15 OF THE FCC RULES. THESE LIMITS ARE DESIGNED TO PROVIDE REASONABLE PROTECTION AGAINST HARMFUL INTERFERENCE WHEN THE EQUIPMENT IS OPERATED IN A COMMERCIAL ENVIRONMENT. THIS EQUIPMENT GENERATES, USES AND CAN RADIATE RADIO FREQUENCY ENERGY AND, IF NOT INSTALLED AND USED IN ACCORDANCE WITH THE INSTRUCTION MANUAL, MAY CAUSE HARMFUL INTERFERENCE TO RADIO COMMUNICATIONS. OPERATION OF THIS EQUIPMENT IN A RESIDENTIAL AREA IS LIKELY TO CAUSE HARMFUL INTERFERENCE IN WHICH CASE THE USER WILL BE REQUIRED TO CORRECT THE INTERFERENCE AT HIS OWN EXPENSE.</p>

**Important:** Damage caused by the disregard of this user manual is not subject to warranty. The dealer and manufacturer will not accept liability for any resulting defects or problems.

- If the device has been exposed to temperature changes due to environmental conditions, do not power on immediately. The resulting condensation could damage the device. Leave the device powered off until it has reached room temperature.
- Ensure the sealing rubber covers of powerCON and XLR connectors are fitted properly when the device is not in use, to avoid water ingress.
- This device falls under protection-class I. Therefore, it is essential that the device be earthed.
- If either lenses or display are damaged (damage may include cracks or gashes in the material) they must be replaced.
- Electrical connections, such as replacing the power plug, must be performed by a qualified person.
- Make sure that the available voltage is not higher than that which is stated in this manual.

- Make sure the power cord is never crushed or damaged by sharp edges. If this should be the case, replacement of the cable must be done by an authorized dealer.
- If the external flexible power cord of this device is damaged, it shall be exclusively replaced by the manufacturer or their service agent or a similar qualified person in order to avoid injury.
- When the device is not in use or before performing maintenance, always disconnect the device from the mains. Only handle the power cord from the plug. Never pull the plug out of a socket by tugging the power cord.
- When powered on for the first time, some smoke or smell may occur. This is caused by coating on metal parts when heated and is normal. If you are concerned, please contact your distributor.
- Do not focus the beam onto flammable surfaces. The minimum distance between the exiting lens of the device and the illuminated surface must be greater than 3 meter.

**Important:** Please be aware that damage caused by any modifications to the device are not subject to warranty. Keep away from children and non-professionals.

## 1.2. GENERAL GUIDELINES

- This device is a lighting effect for professional use on stages, in discotheques, theatres, etc. the device was designed for indoor and outdoor use.
- This fixture is only allowed to be operated within the maximum alternating current as stated in the technical specifications in section 2 of this manual.
- Handle the device with care, avoid shaking or using force when installing or maintaining the device.
- If you use the quick lock cam when rigging the device, make sure the quick lock fasteners are located in the quick lock holes correctly and securely.
- Operate the device only after having familiarized yourself with its functions. Do not permit operation by persons not qualified for operating the device. Most damage is the result of unprofessional operation.
- Please use the original packaging if the device is to be transported.
- The applicable temperature for the device is between -20°C to 45°C. Do not use the device outside of this temperature range.
- The light source of this luminaire is not replaceable; when the light source reaches its end of life the whole luminaire shall be replaced.

**Important:** For safety reasons, please be aware that all modifications to the device are forbidden. If this device is operated in any way different to the ones described in this manual, the product may suffer damage and the warranty becomes void. Furthermore, any other operation may lead to short-circuits, burns, electric shocks etc.

## 2. FEATURES

### POWER SUPPLY:

- AC100-240V~, 50/60Hz
- Power Consumption: 750W

### LIGHT SOURCE:

- LED: White LED 430W, 8000±400K Color Temperature
- Extremely long Life: >20,000H

### MOVEMENT

- Pan movement: infinite rotation
- Tilt movement: infinite rotation
- Advanced moving system: fast, stable and quite, auto x-y repositioning

**COLORS:**

- CMY+CTO color mixing, uniform, linear and speed can be adjustable
- 1 Color wheel: 7 dichroic filters + open, indexable

**GOBOS:**

- Rotating gobo wheel: 7 interchangeable, rotating and indexable gobo + open
- "Slot in & out" gobo wheel system

**FEATURES:**

- 1 Control channel modes: 60 channels
- 2 Operation modes: DMX-512, Master / Slave mode
- Strobe effect with 1-25 flashes per second and pulse effect
- Rotating Prisms: 5-facet circular and 4-facet linear
- Animation effect: can make special dynamic effect
- Blades system
- Focus: Motorized focus
- Frost: 0%~100% linear change frost
- Iris: 5%~100% linear change iris, pulse iris effect
- Dimmer: 0%~100% full range dimming

**DISPLAY:**

- Advanced and convenient full-color LCD
- Can be changed 180° reverse to fit for different installation position

**SOFTWARE:**

- Upgrades: fast and convenient through DMX cable with DMX-512 controller
- Reset DMX address, reset can all be done by the DMX controller
- Running time of fixture on display for reference

**OTHER SPEC:**

- Input signal isolation: guarantees stable signal transmission without interference
- Advanced RDM function

**WEIGHT**

- Net weight: 30.8 kg

**3. FIXTURE OVERVIEW**

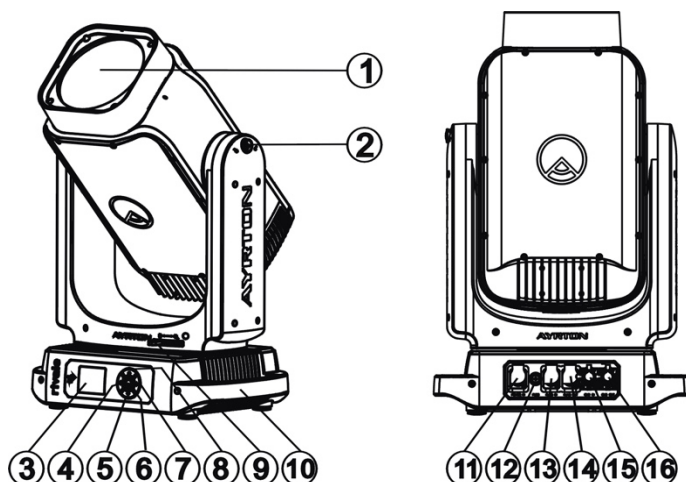

- 1) Lenses Assembly
- 2) Tilt Lock
- 3) Display
- 4) Left-button
- 5) Down-button
- 6) Center-button
- 7) Right-button
- 8) Up-button
- 9) Pan Lock
- 10) Handle
- 11) Power In
- 12) Fuse
- 13) RJ45 In
- 14) RJ45 Out
- 15) DMX In
- 16) DMX Out

**4. DRAWINGS**

Scan the QR code on the cover page to download the related drawings:

- 4.1. Fixture Dimension
- 4.2. Color Wheel
- 4.3. Rotating Gobo Wheel
- 4.4. Fix Gobo Wheel

## 4.5.Animation Dimension

# 5. INSTALLATION INSTRUCTIONS

## 5.1.Rigging the device

	<p><b>CAUTION!</b> PLEASE CONSIDER THE RESPECTIVE NATIONAL NORMS DURING THE INSTALLATION. THE INSTALLATION MUST ONLY BE CARRIED OUT BY A QUALIFIED PERSON.</p>
--	--

- The installation of the effect has to be built and constructed in a way that it can hold 10 times the weight for 1 hour without any harming deformation.
- The installation must always be secured with a secondary safety attachment, e.g. an appropriate safety rope.
- Never stand directly below the device when mounting, removing or servicing the fixture.
- The operator has to make sure the safety relating and machine technical installations are approved by an expert before taking the device into operation for the first time.
- These installations have to be approved by a skilled person once a year.
- Overhead mounting requires extensive experience, including amongst others calculating working load limits, installation material being used, and periodic safety inspection of all installation material and the device. If you lack these qualifications, do not attempt the installation yourself. Improper installation can result in bodily injury.

## 5.2 Rigging using the omega brackets

**Important:** This step is very important to ensure safe rigging of the fixture.

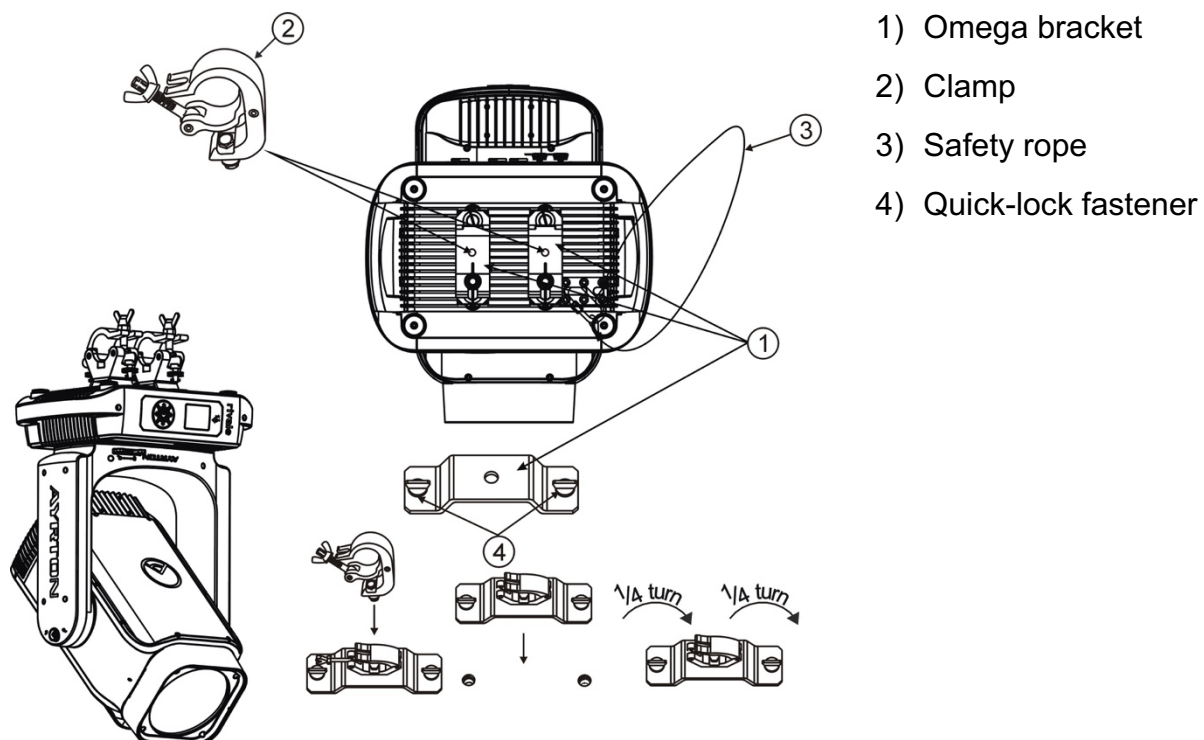

- Fix the clamp to the bracket by tightening the M12 nut and bolt to the bracket through the  $\Phi 13$  hole in the middle of the bracket.
- Insert the quick-lock fasteners of the first Omega holder into the respective holes on the bottom of the device. Tighten the quick-lock fasteners fully clockwise.
- Install the second Omega holder.

- Pull the safety cable through the holes on the bottom of the base and over the trussing system or another suitable rigging point. Insert the end into the carabiner and tighten the safety screw.

### 5.3. RIGGING DRAWINGS

**Important:**

Overhead rigging requires extensive experience, including (but not limited to) calculating working load limits, specifying installation/ rigging materials, and periodic safety inspection of all installation material as well as the device. If you lack these qualifications, do not attempt the rigging of this device yourself. Improper installation/ rigging can result in serious bodily injury.

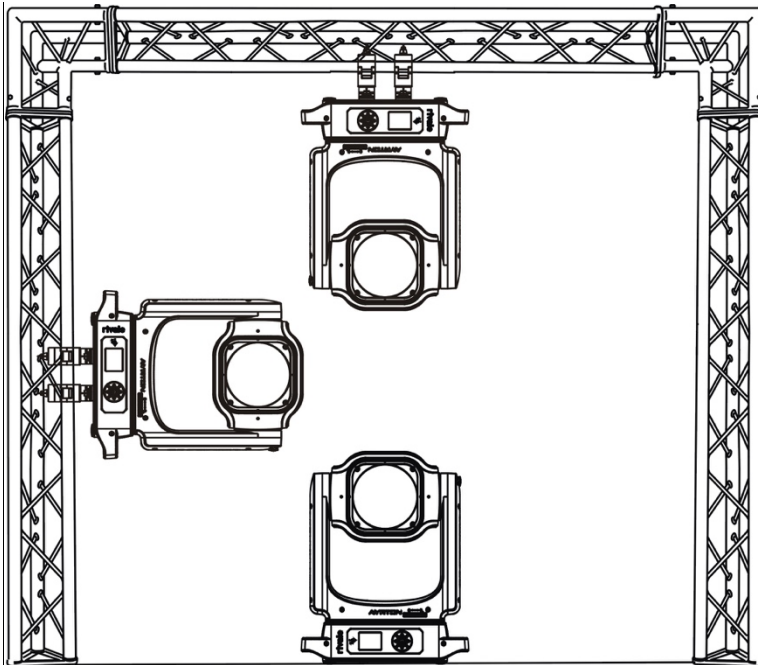

- Be sure this fixture is kept at least 0.1m away from any flammable materials (decoration etc.).
- Always use and install the supplied safety cable as a safety measure to prevent accidental damage and/or injury in the event the clamp fails.

- Warnings! Please DO NOT let other external intense lights to shine through the fixture front lens, it may cause significant internal damages !
- When install fixture outdoor at day time (with power off), please make sure that the fixture front lens is NOT facing the sun.
- When use fixture outdoor at day time (with power on), please avoid fixture front lens facing the sun.
- When fixture is on standby outdoor at day time (with power on), please make sure the "sun protection" mode is ON (default).

### 6. DMX-512 CONTROL CONNECTION

Connect the provided male side of the XLR cable to the female XLR output of your controller and the female side of the XLR cable to the male XLR input of the device. You can connect multiple devices together in a serial fashion. The cable needed should be two core, screened cable with XLR input and output connectors. Please refer to the diagram below.

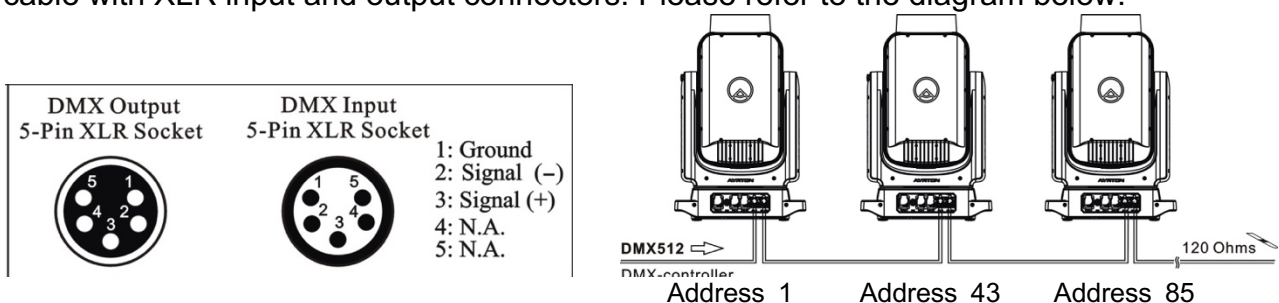

## 7. DMX-512 CONNECTION WITH DMX TERMINATOR

For installations where the DMX cable has to run over a long distance or is in an electrically noisy environment, such as in a discotheque, it is recommended to use a DMX terminator. This helps in preventing corruption of the digital control signal caused by electrical noise. The DMX terminator is an XLR plug with a 120 Ω resistor connected between pins 2 and 3, which is then plugged into the output (female) XLR socket of the last fixture in the chain. Please see illustrations below.

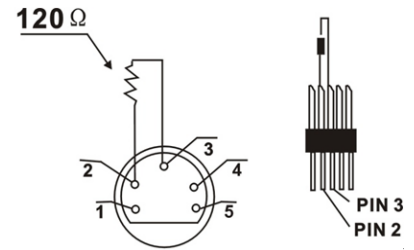

## 8. DEVICE DMX START ADDRESS SELECTION

All fixtures should be given a DMX starting address when using a DMX signal, so that the correct fixture responds to the correct control signals. This digital starting address is the channel number from which the fixture starts to “listen” to the digital control information sent out from the DMX controller. The allocation of this starting address is achieved by setting the correct address number on the display located on the base of the device.

You can set the same starting address for all fixtures or a group of fixtures, or set different addresses for each fixture individually.

If you set the same address on all devices, all the devices will start to “listen” to the same control signal from the same channel number. In other words, changing the settings of one channel will affect all the fixtures simultaneously.

If you set a different address, each unit will start to “listen” to the channel number you have set, based on the quantity of control channels of the unit. That means changing the settings of one channel will affect only the selected device.





In the case of the LED moving head, in 42 channel mode, you should set the starting address of the first unit to 1, the second unit to 43 (42 + 1), the third unit to 85 (42 + 43), and so on.



## 9. OPERATING INSTRUCTIONS OF THE INTERNAL DMX WIRELESS SYSTEM

Scan the QR code on the cover page to download the MANUAL to check.

## 10. DISPLAY

The Display offers several features: you can set the starting address, run the pre-programmed program or reset the device.

The main menu is accessed by double clicking  -button until the display starts flashing. Browse through the menu by pressing the  -button,  -button,  -button or  - button .

Press  for 2 seconds in order to exit menu, double click  for confirm. After accessing the edit mode, the unit will automatically exit to the main menu after 15 seconds from the last button press.



When the unit is powered on, if no data signal is connected after 1 minute, then the display will switch off automatically.

Scan the QR code on the cover page to download the MANUAL to check the DISPLAY MENU.



### 11. DMX PROTOCOL

Scan the QR code on the cover page to download the DMX CHART.

### 12. ERROR MESSAGES

Scan the QR code on the cover page to download the MANUAL to check.

### 13. CLEANING AND MAINTENANCE

	<b>CAUTION!</b> DISCONNECT FROM MAINS BEFORE STARTING MAINTENANCE OPERATION.	
	<p style="text-align: center;"><b>CAUTION!</b></p> <p>ALWAYS RUN AN IP TEST USING THE AYRTON IP TEST KIT FOLLOWING ANY MAINTENANCE OPERATION! FAILURE TO COMPLY WITH THIS CLAUSE WILL VOID THE WARRANTY!</p> <p>THE OPERATOR MUST FOLLOW STRICTLY THE VACUUM AND PRESSURE SETTING VALUES AS BELOW, OR USE THE CORRESPONDING PRESET FIXTURE MENU TO RUN THE IP TEST. ANY OVERPRESSURE OPERATION MAY CAUSE ACCIDENTAL DAMAGE OR INJURY.</p>	 AYRTON IP TEST KIT

	Minimum value		Maximum value		Steady time (Hold time)
	Kpa	Psi	Kpa	Psi	
Vacuum	-35	-5.08	-40	5.80	10
Pressure	25	3.63	30	4.35	10

Once the covers removed and before set them back, check the cover gasket to avoid any leak due to gasket damage.

Cross tightening the die-casting covers HEX screws at the right torque value.

Use a Torque Screwdriver set at 1,4Nm (12,4in/lbf) to fasten correctly the (10) HEX head screws for each cover.

The following points have to be considered during inspection:

- 1) All screws for installing the devices or parts of the device have to be tightly connected and must not be corroded.
- 2) There must not be any deformations to the housing, lenses, rigging and installation points (ceiling, suspension, trussing).
- 3) Motorized parts must not show any signs of wear and must move smoothly without issue.
- 4) The power supply cables must not show any damage, material fatigue or sediment.

Further instructions depending on the installation location and usage have to be adhered to by a qualified installer and any safety concerns have to be removed.

In order to ensure the device remains in good condition and does not fail prematurely, we suggest regular maintenance.

- 1) Clean the outside lens each week to avoid loss of output due to accumulation of dust/ dirt on the lens.
- 2) Clean the fans each week to ensure maximum airflow and efficient thermal cooling. This will ensure the light source is operated in the best possible condition.
- 3) A detailed electrical check by an approved electrician every quarter to make sure that the circuit contacts are in good condition. This will prevent poor circuit contacts and the resultant overheating.

We recommend frequent cleaning of the device. Please use a moist, lint- free cloth. Never use alcohol or solvents.

Please refer to the instructions under “Installation instructions”.

Should you need any spare parts, please order genuine parts from your local dealer.



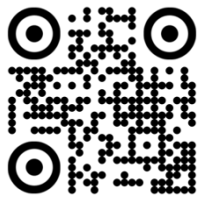

scan for more on  
[www.ayrton.eu](http://www.ayrton.eu)



**AYRTON**  
Digital Lighting

2 Rue de Vitruve - 91140 - Villebon-sur-Yvette - France